

# Showmanship

Show: Summa In The Hamptons

Date: Aug 20, 2022

## Age Divisions

- 38. All-Breed W/T
- 39. Youth W/T 5-10
- 40. Youth W/T 11-18

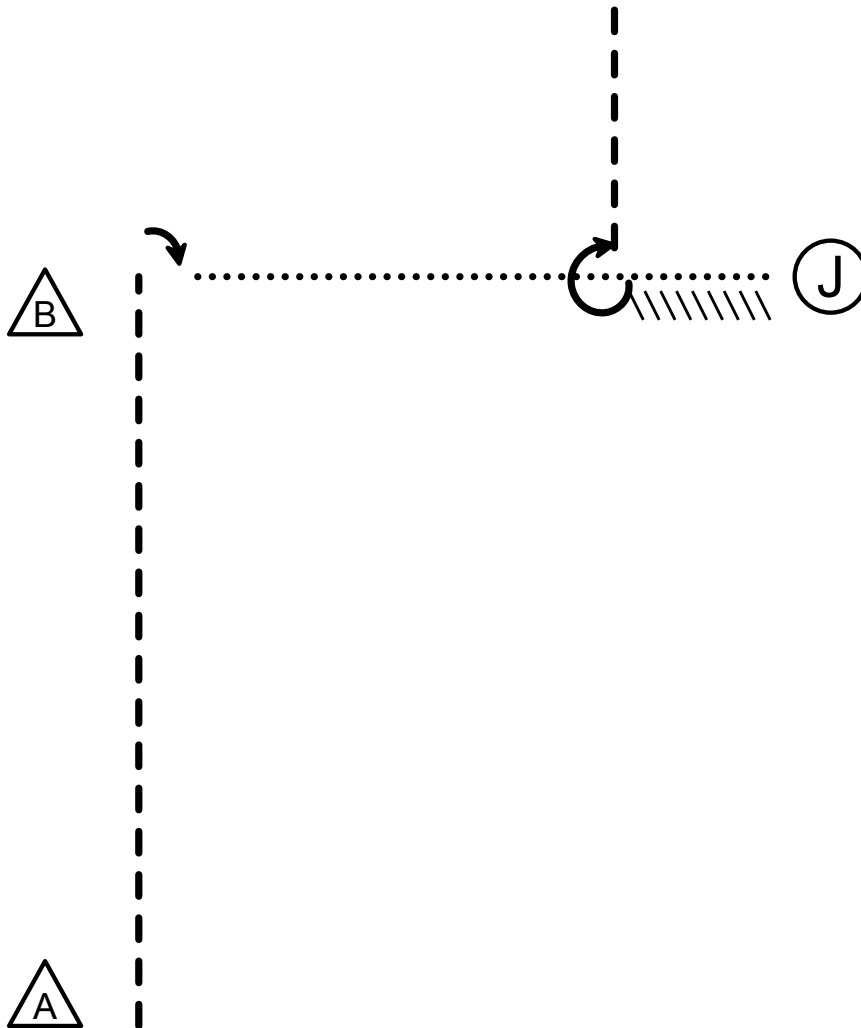

Pattern design by NULL

Be ready at A

1. Trot toward judge as shown
2. Stop and perform a 90° turn
3. Walk to judge set up for inspection
4. When dismissed, back one horse length
5. Perform a 270° turn
6. Exit at a walk

Generated from Equiscribe for iOS  
Scan the code to see your results as they are posted



# Showmanship

Age Division

41. Amateur W/T

Show: Summa In The Hamptons

Date: Aug 20, 2022

---

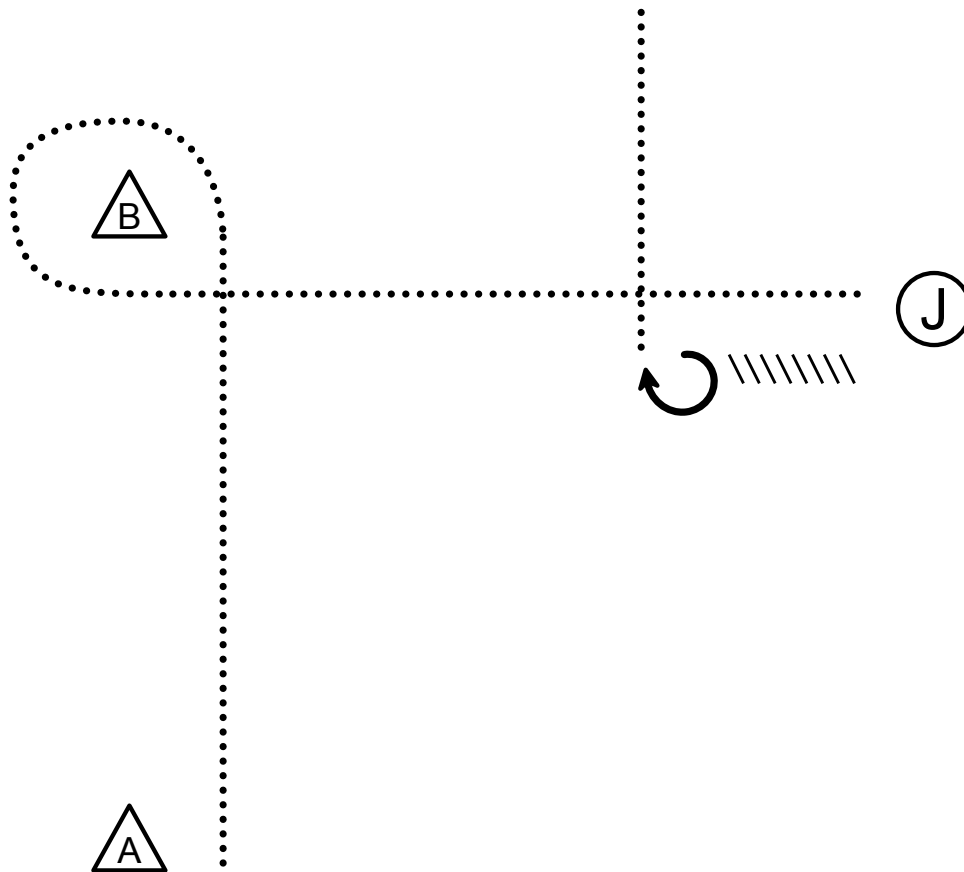

- 
1. Walk from A to B
  2. Walk around B
  3. Walk to judge
  4. Set up
  5. Inspection
  6. Back one horse length
  7. Turn 270° to the right
  8. Walk to exit

Generated from Equiscribe for iOS  
Scan the code to see your results as they are posted



# Showmanship

Show: Summa In The Hamptons

Date: Aug 20, 2022

## Age Divisions

44. Novice Amateur

42. All-Breed Youth

43. All-Breed Adult

47. Novice Youth

48. Youth 13 & Under

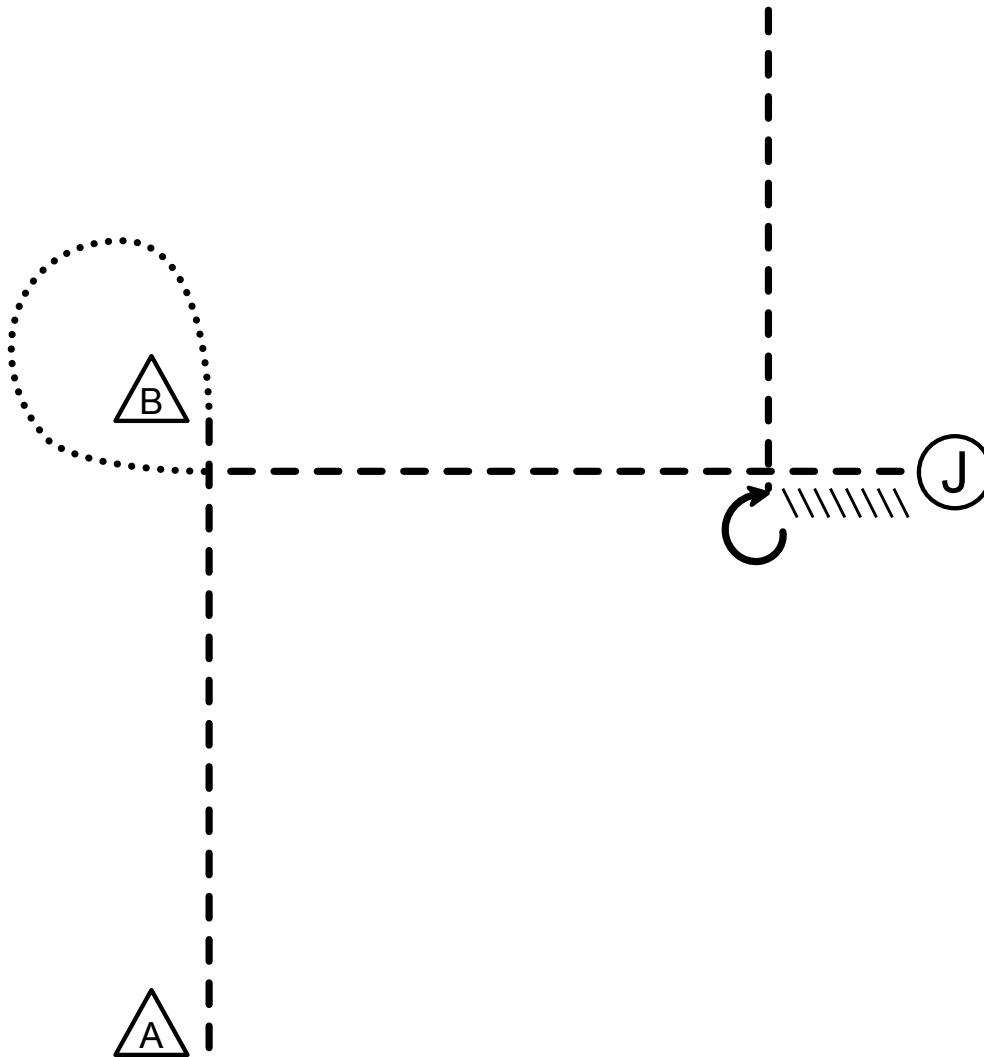

1. Trot from A to B
2. Walk around B
3. Trot to the judge and set up for inspection
4. Back one horse length
5. Turn 270° to the right
6. Trot to exit

Generated from Equiscribe for iOS  
Scan the code to see your results as they are posted



# Showmanship

## Age Divisions

- 45. Amateur
- 46. Amateur SPB
- 49. Youth 18 & Under

Show: Summa In The Hamptons

Date: Aug 20, 2022

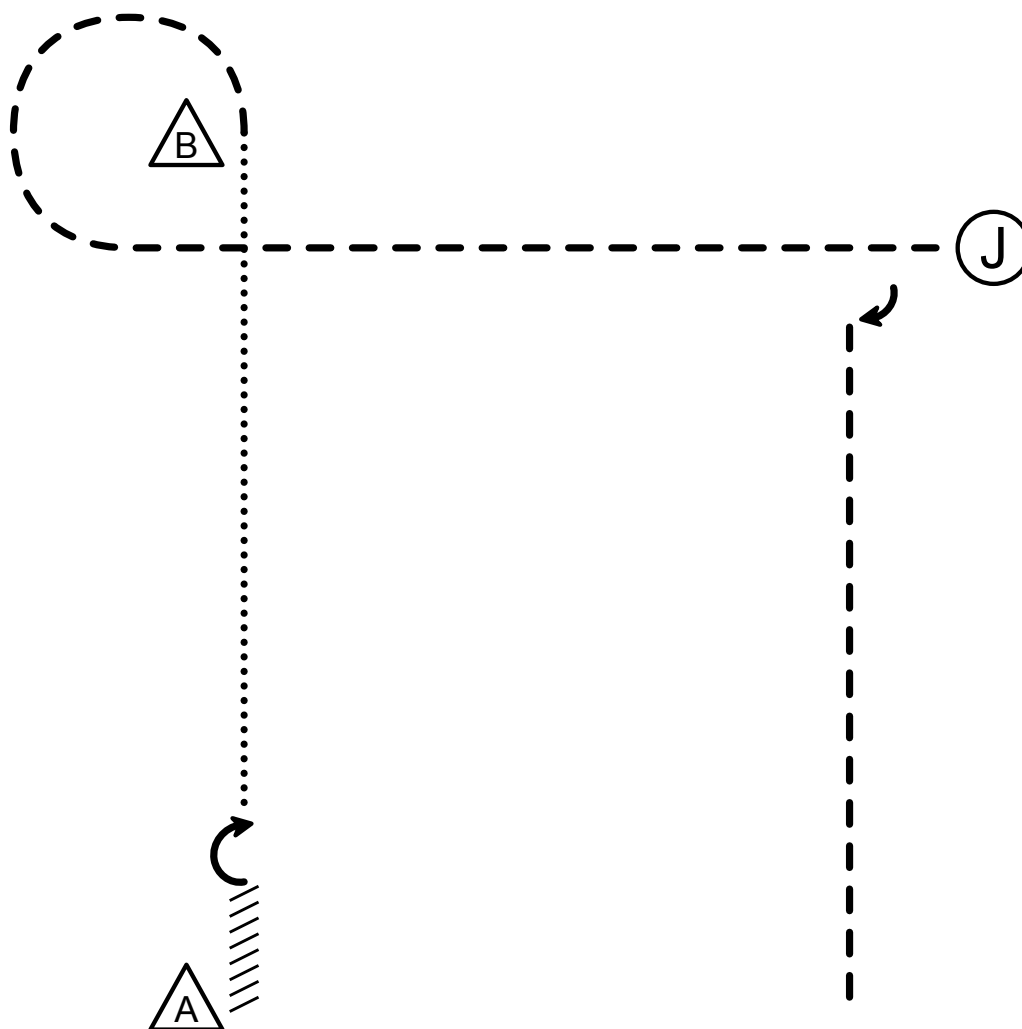

Pattern design by NULL

1. Back 4 steps
2. Turn 180°
3. Walk to B
4. Trot around B and to judge
5. Stop and set up for inspection
6. Turn 90° and trot

Generated from Equiscribe for iOS  
Scan the code to see your results as they are posted



# English Equitation

Show: Summa In The Hamptons

Date: Aug 20, 2022

## Age Divisions

75. Youth W/T 5-10\*

76. Youth W/T 11-18

77. Amateur W/T

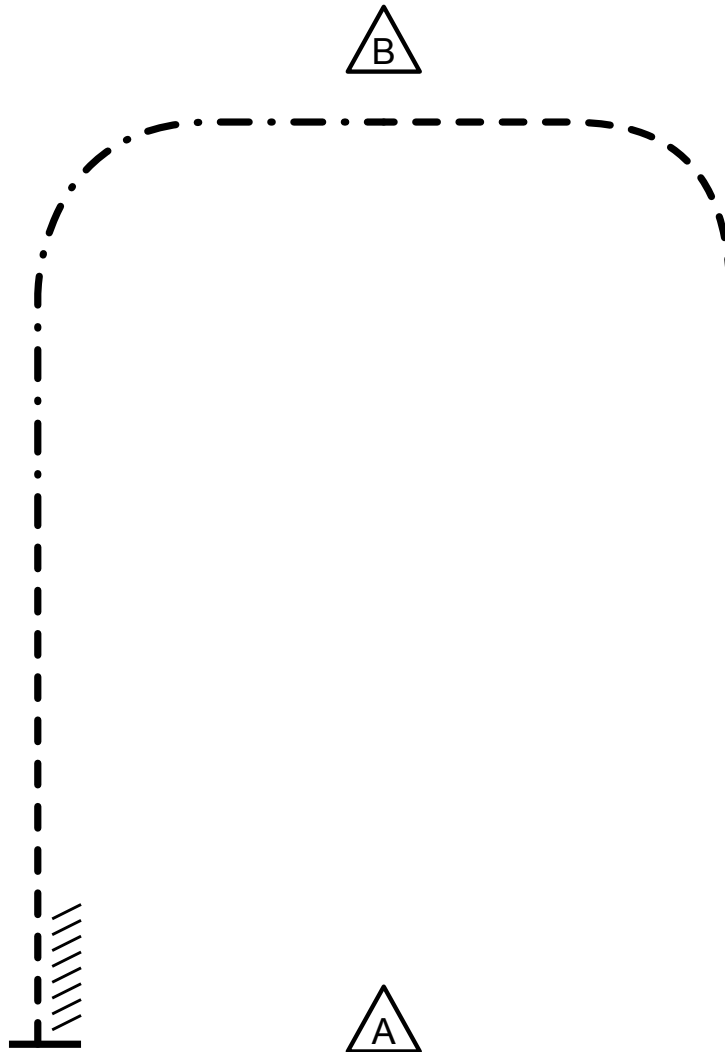

### Pattern design by NULL

Be ready at A

1. Walk approximately 2 horse lengths
2. Posting trot right diagonal to B
3. At B, sitting trot halfway wack to A
4. Posting trot left diagonal until even with A
5. Stop and back approximately 1 horse length

Pattern is complete.

Generated from Equiscribe for iOS  
Scan the code to see your results as they are posted



# English Equitation

Show: Summa In The Hamptons

Date: Aug 20, 2022

## Age Divisions

80. Novice Youth

81. Youth 13 & Under

83. Novice Amateur

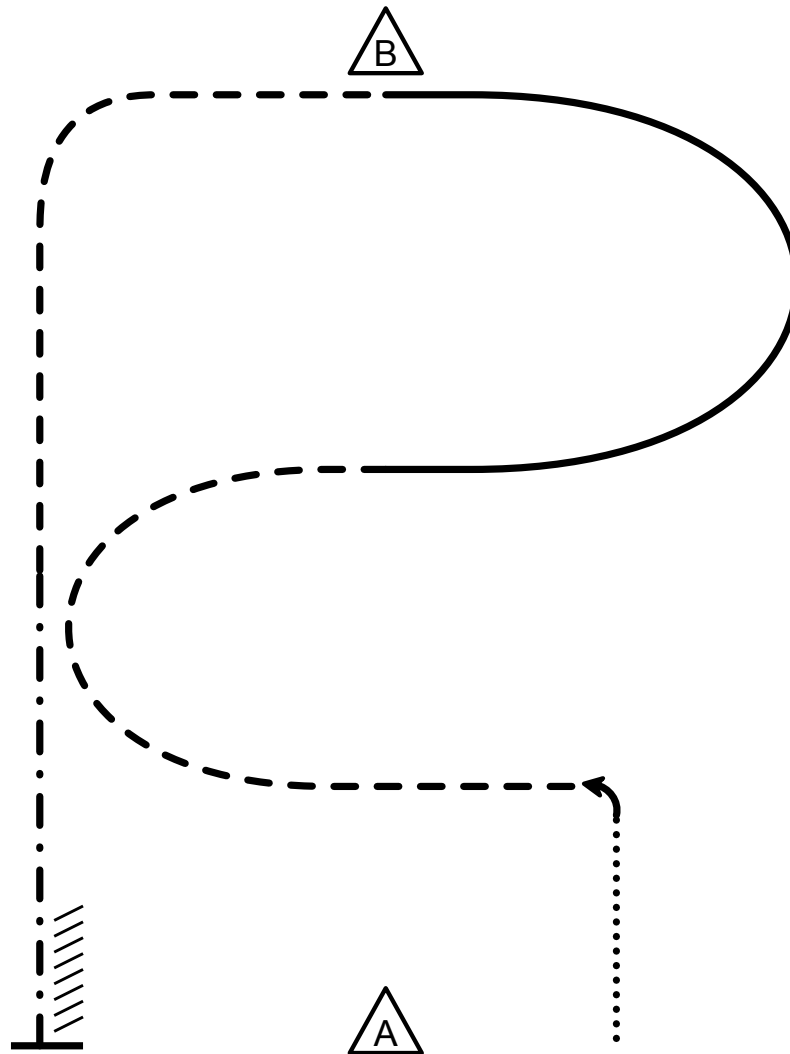

### Pattern design by NULL

Be ready at A

1. Walk approximately 2 horse lengths past A. Stop
2. Perform 90° forehand turn to the left
3. Posting trot left diagonal in half circle
4. Canter left lead in half circle to B
5. At B, posting trot right diagonal halfway back to A
6. Sitting trot until even with A
7. Stop and back approximately 1 horse length

Pattern is complete.

Generated from Equiscribe for iOS  
Scan the code to see your results as they are posted



# English Equitation

Show: Summa In The Hamptons

Date: Aug 20, 2022

## Age Divisions

82. Youth 18 & Under

84. Amateur

85. Amateur SPB

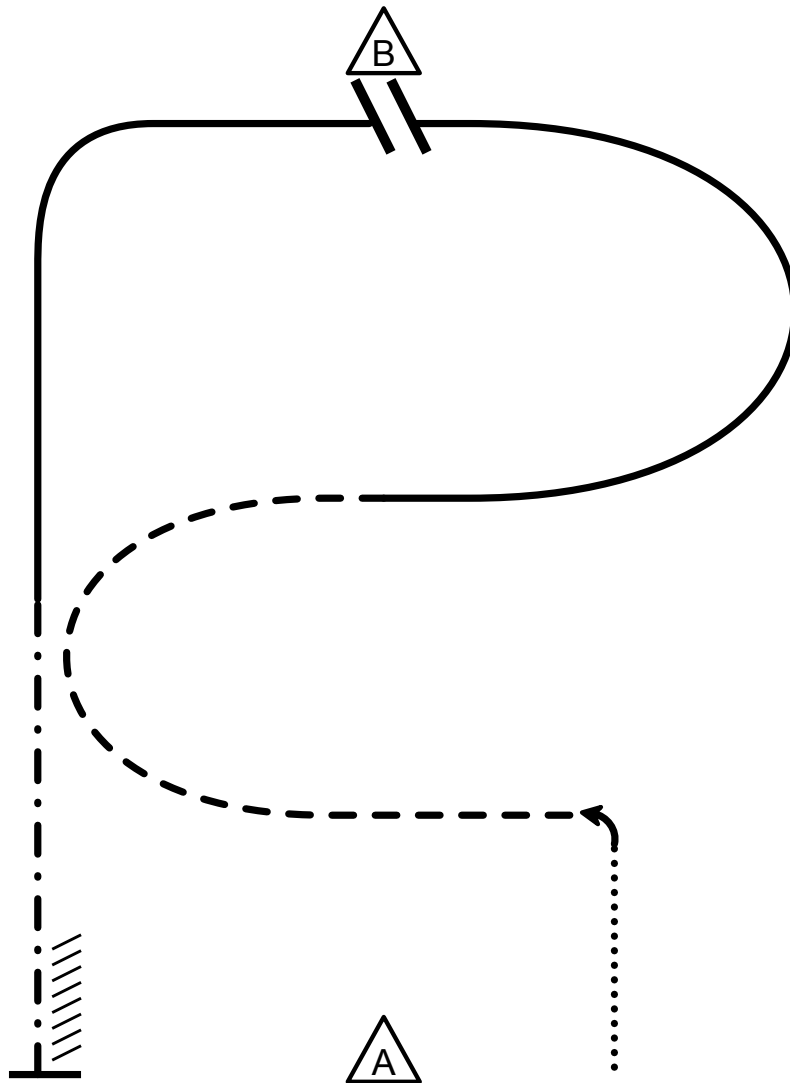

Pattern design by NULL

Be ready at A

1. Walk approximately 2 horse lengths past A. Stop
2. Perform 90° forehand turn to the left
3. Posting trot left diagonal in half circle
4. Canter left lead in half circle to B
5. At B, change leads (simple or flying) and counter canter curve
6. Halfway back to A, sitting trot until even with A
7. Stop and back approximately 1 horse length

Pattern is complete.

Generated from Equiscribe for iOS  
Scan the code to see your results as they are posted



# Ranch Riding

Age Divisions

86. All-Breed Youth W/T  
87. All-Breed Adult W/T

Show: Summa In The Hamptons

Date: Aug 20, 2022

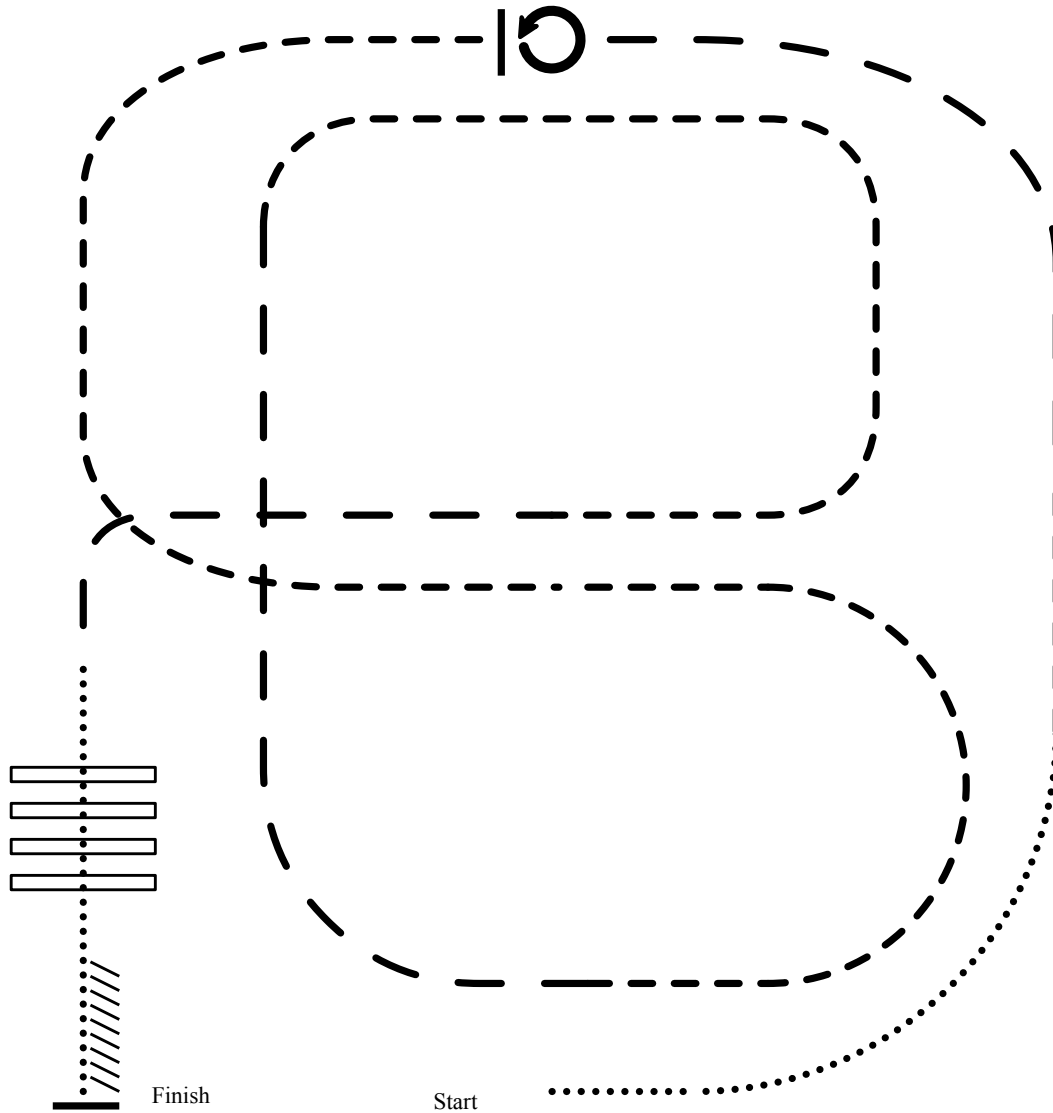

1. Walk
2. Trot
3. Extend the trot; At the top of the arena, stop
4. 360° turn to the left
5. Trot ½ circle, trot to the center
6. Trot ½ circle
7. Extended trot up the long side of the arena
8. Collect back to a trot around the top of the arena and back to center
9. Extended trot
10. Walk over poles
11. Stop and back

Generated from Equiscribe for iOS  
Scan the code to see your results as they are posted





# Ranch Riding

Show: Summa In The Hamptons

Date: Aug 20, 2022

## Age Divisions

88. Novice Youth

89. Youth

90. Novice Amateur

91. Amateur

92. Open

93. All-Breed Open

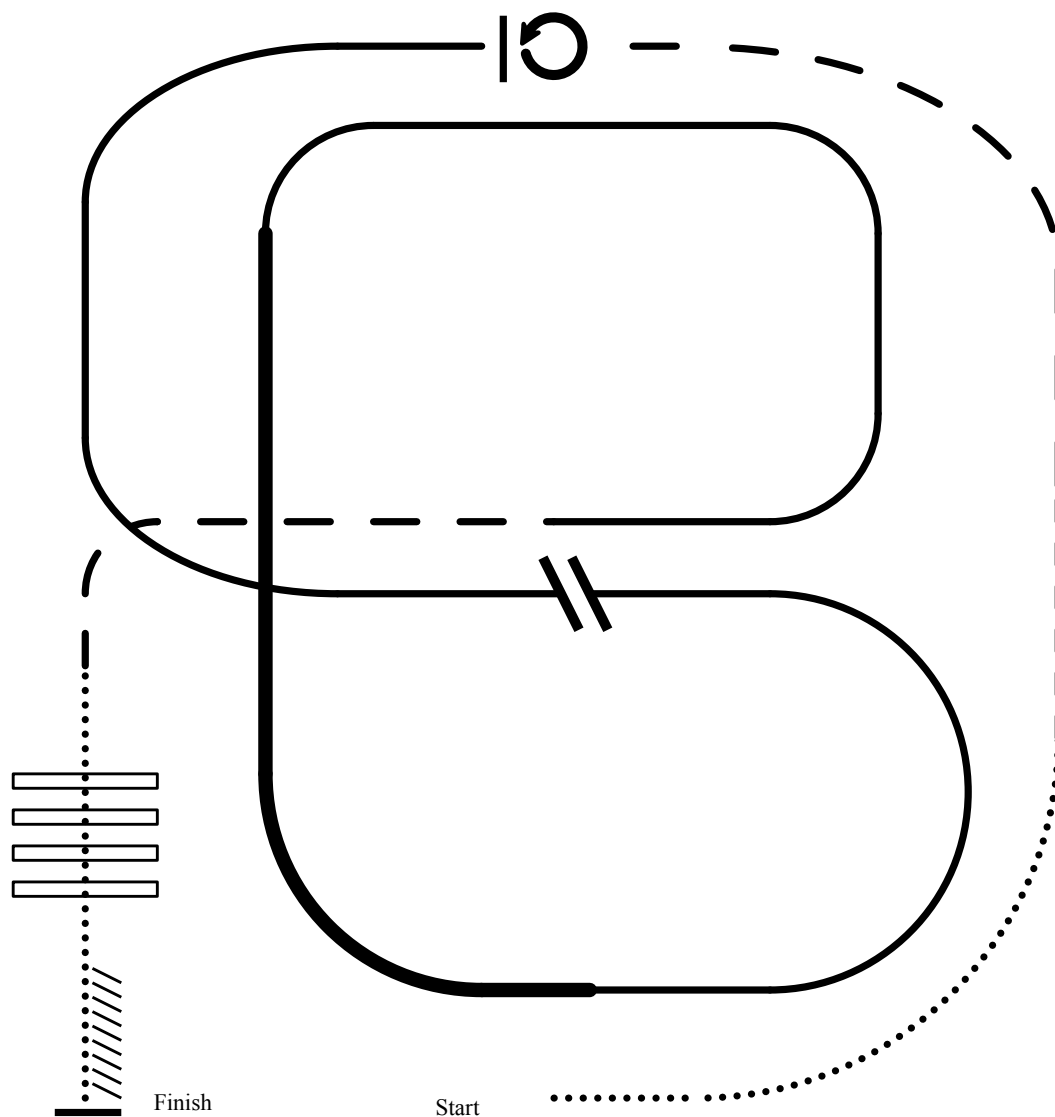

1. Walk
2. Trot
3. Extend the trot; At the top of the arena, stop
4. 360° turn to the left
5. Left lead ½ circle, lope to the center
6. Change leads (simple or flying)
7. Right lead ½ circle
8. Extended lope up the long side of the arena (right lead)
9. Collect back to a lope around the top of the arena and back to center
10. Break down to an extended trot
11. Walk over poles
12. Stop and back

Generated from Equiscribe for iOS  
Scan the code to see your results as they are posted



# Reining

Show: Summa In The Hamptons

Date: Aug 20, 2022

## Age Divisions

- 94. Youth
- 95. Novice Amateur
- 96. SPB
- 97. Amateur
- 98. Open

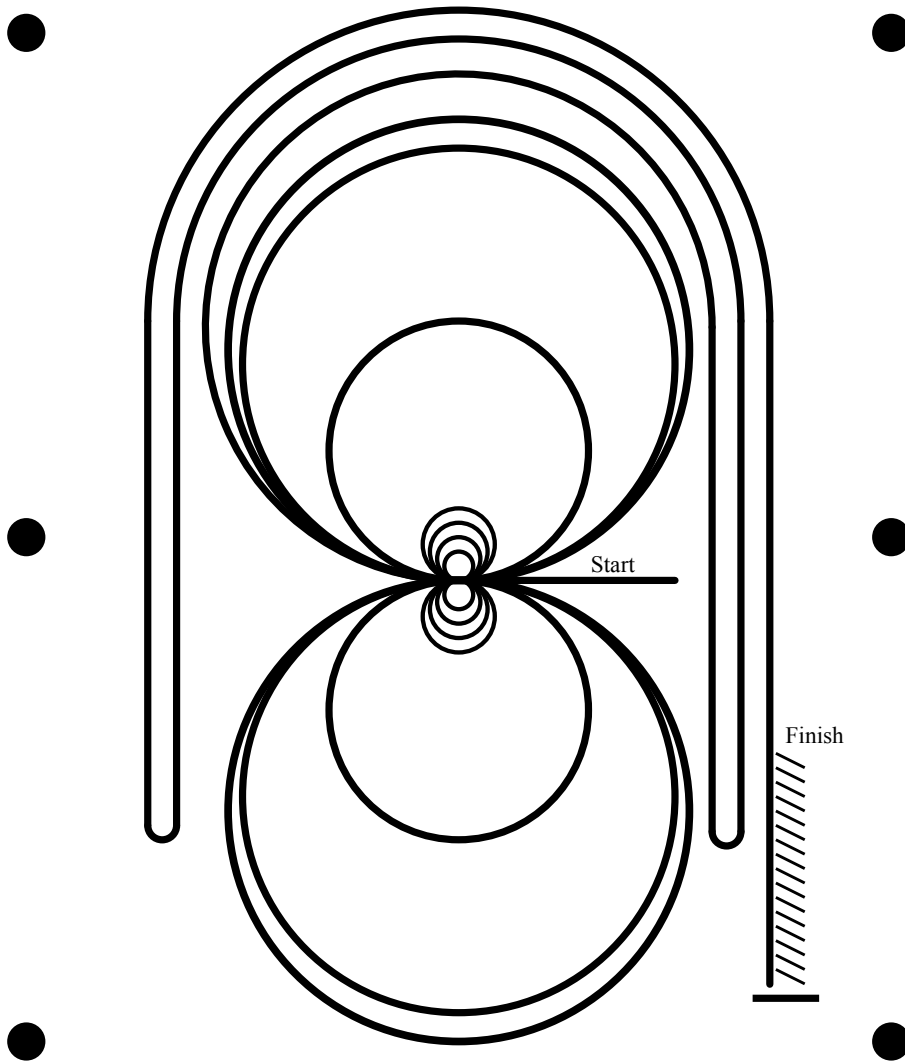

Horse must walk or stop prior to starting pattern. Beginning at the center of the arena facing the lead

1. Complete four spins to the left.
2. Complete four spins to the right. Hesitate.
3. Beginning on the right lead, complete three circles to the right: the first circle large and fast; the second circle
4. Complete three circles to the left: the first circle large and fast; the second circle small and slow; the third circle
5. Begin a large circle to the right but do not close this circle. Run straight down the right side of the arena past t
6. Continue back around the previous circle but do not close this circle. Run down the left side of the arena past
7. Continue back around the previous circle but do not close this circle. Run down the right side of the arena pas

Rider may drop bridle to the designated judge.

Generated from Equiscribe for iOS  
Scan the code to see your results as they are posted



# Tcpej 'Reining

Age Division

99. Open Ranch

Show: Summa In The Hamptons

Date: Aug 20, 2022

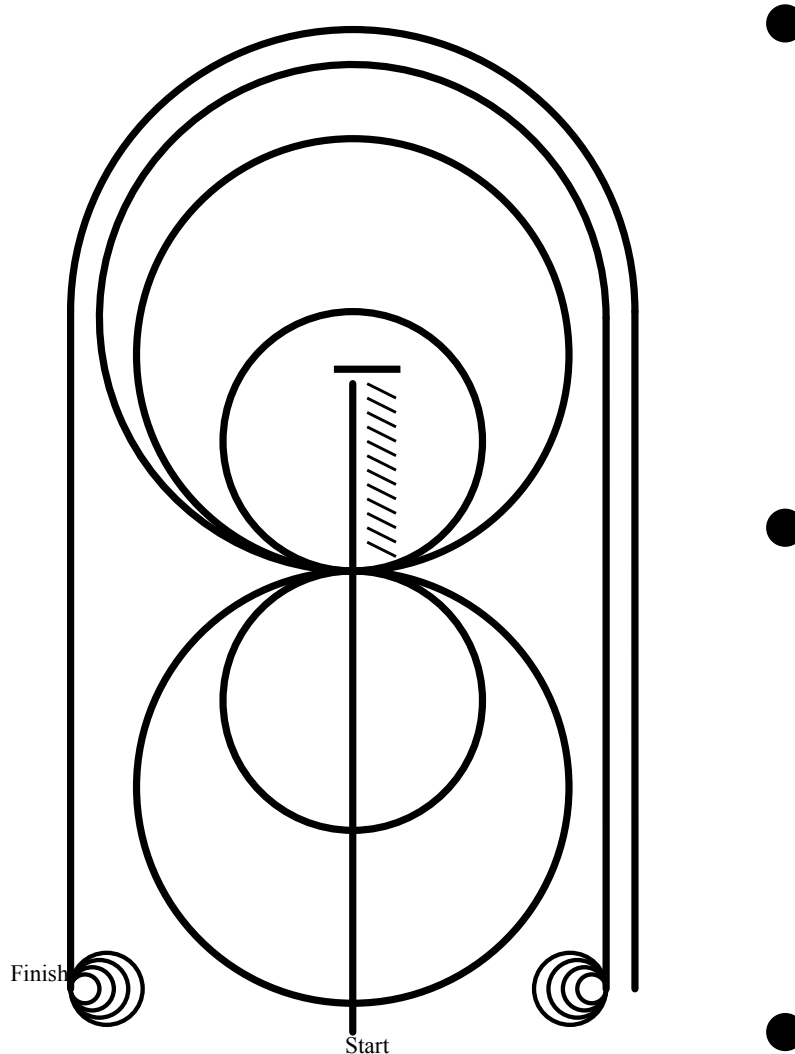

Horse must walk or stop prior to starting pattern. Beginning at the center of the arena facing the long side.

1. Start at end of arena. Run past center marker. Sliding Stop.
2. Back at least 10 feet to center.  $\frac{1}{4}$  turn left.
3. Complete two circles right: the first circle large and fast; the second small and slow. Change leads at the center.
4. Complete two circles left: the first circle large and fast; the second small and slow. Change leads at the center.
5. Begin a large fast circle to the right but do not close it. Run around the end of the arena and past center marker.
6. Complete  $3\frac{1}{2}$  spins right
7. Run back around end of arena past center marker and sliding stop.
8. Complete  $3\frac{1}{2}$  spins left
9. Hesitate to complete pattern

Rider may drop bridle to the designated judge.

Generated from Equiscribe for iOS  
Scan the code to see your results as they are posted



# Ranch Pleasure

Show: Summa In The Hamptons

Date: Aug 20, 2022

## Age Divisions

- 100. Open
- 102. Novice Youth
- 104. Youth
- 106. Novice Amateur
- 108. Amateur
- 110. All-Breed

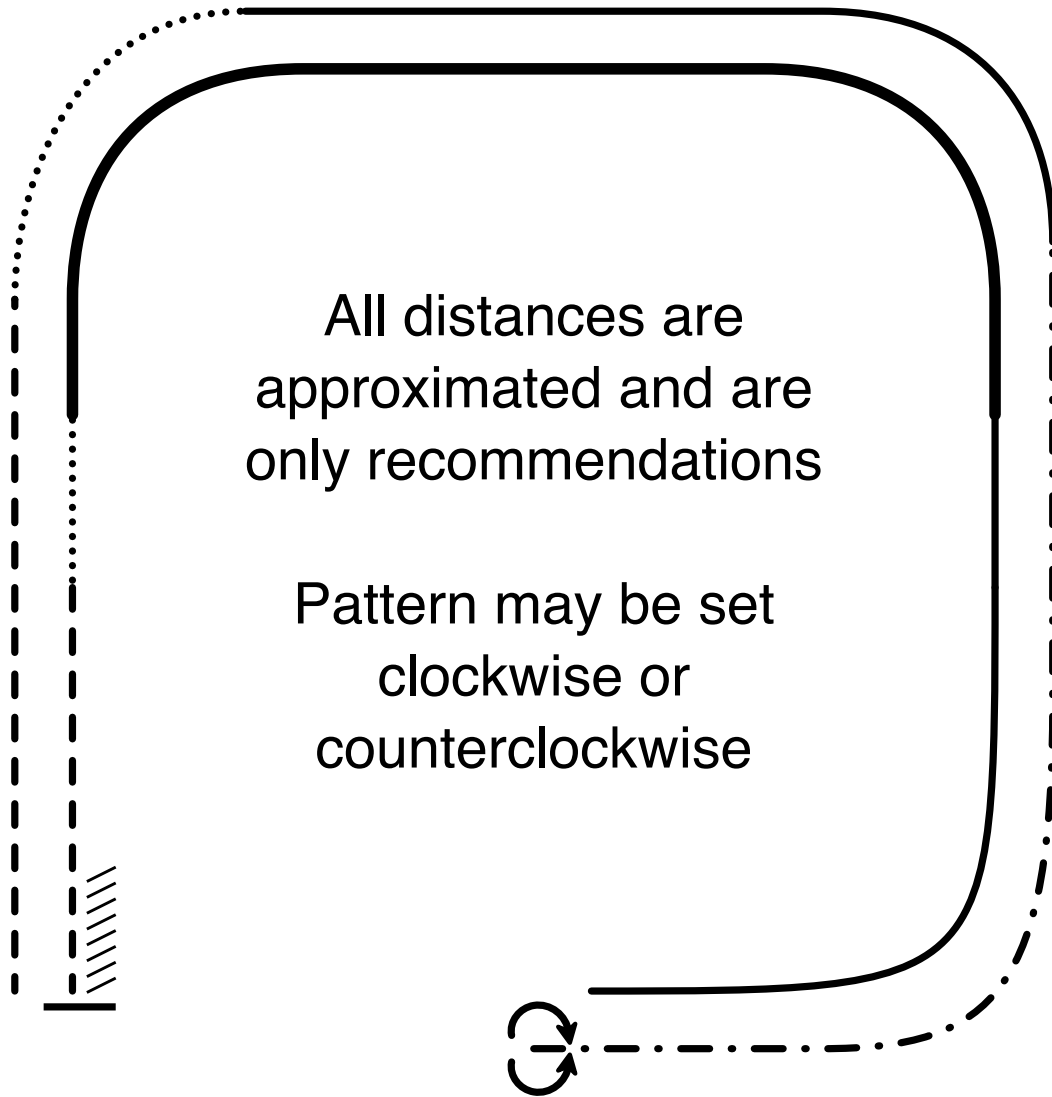

1. Trot
2. Extended walk
3. Lope
4. Extended trot
5. Stop; Reverse
6. Lope
7. Extended lope
8. Walk
9. Trot
10. Stop and back

Generated from Equiscribe for iOS  
Scan the code to see your results as they are posted



# Ranch Trail

Age Division

101. Open

109. Amateur

Show: Summa In The Hamptons

Date: Aug 21, 2022

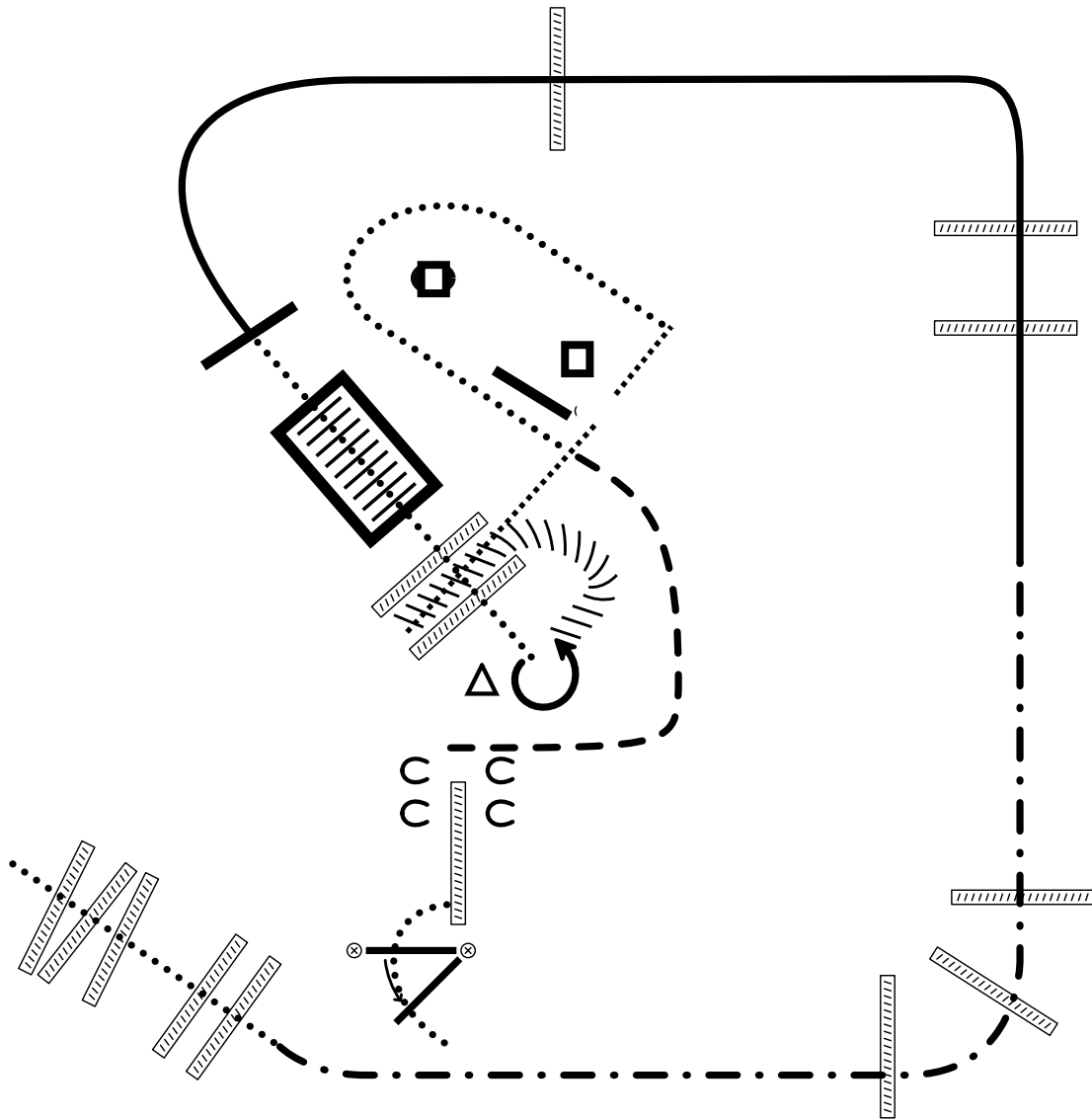

1. Walk over logs
2. Extended trot around corner poles
3. Lope left lead over poles and arc around towards bridge and stop
4. Walk up onto bridge and over poles, stop at cone
5. Pivot 3/4 to left, back around and into opening
6. Walk up to log drag, drag around object, return to first standard
7. Trot up to sidepass
8. Sidepass left
9. Walk up to gate, work gate left hand to complete

Generated from Equiscribe for iOS  
Scan the code to see your results as they are posted



# Ranch Trail

## Age Division

103. Novice Youth  
105. Youth  
107. Novice Amateur  
111. All-Breed

Show: Summa In The Hamptons

Date: Aug 21, 2022

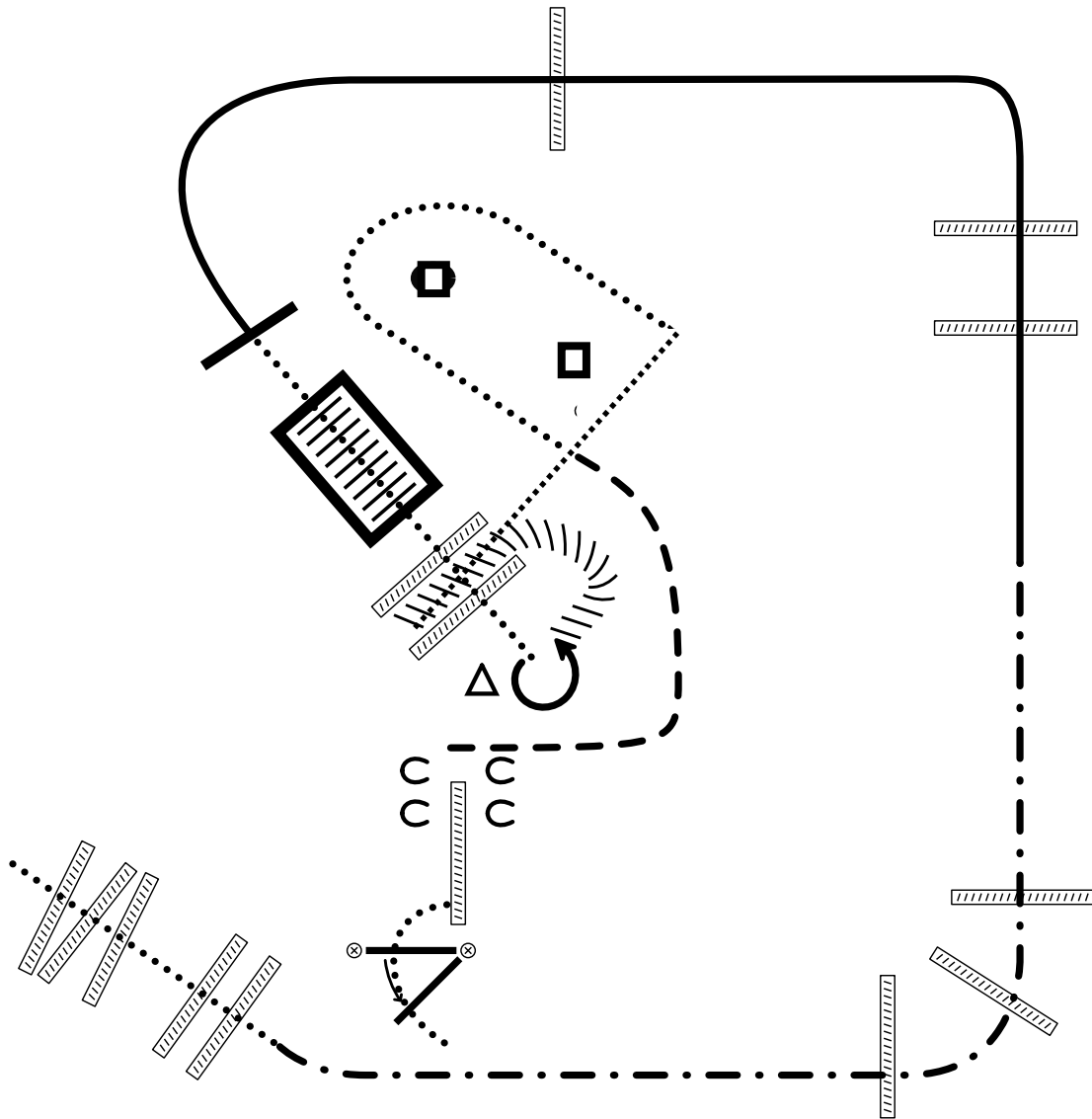

1. Walk over logs
2. Extended trot around corner poles
3. Lope left lead over poles and arc around towards bridge and stop
4. Walk up onto bridge and over poles, stop at cone
5. Pivot 3/4 to left, back around and into opening
6. Walk a circle to the left around the first standard and object
7. Trot up to sidepass
8. Sidepass left
9. Walk up to gate, work gate left hand to complete

Generated from Equiscribe for iOS  
Scan the code to see your results as they are posted



# Trail

Show: Summa In The Hamptons  
Date: Aug 20, 2022

## Age Divisions

- 112. Yearling In Hand
- 113. Amateur Yearling In Hand
- 114. SPB Yearling In Hand
- 115. All Breed W/T
- 117. Youth W/T 5-10
- 118. Youth W/T 11-18
- 119. Amateur W/T

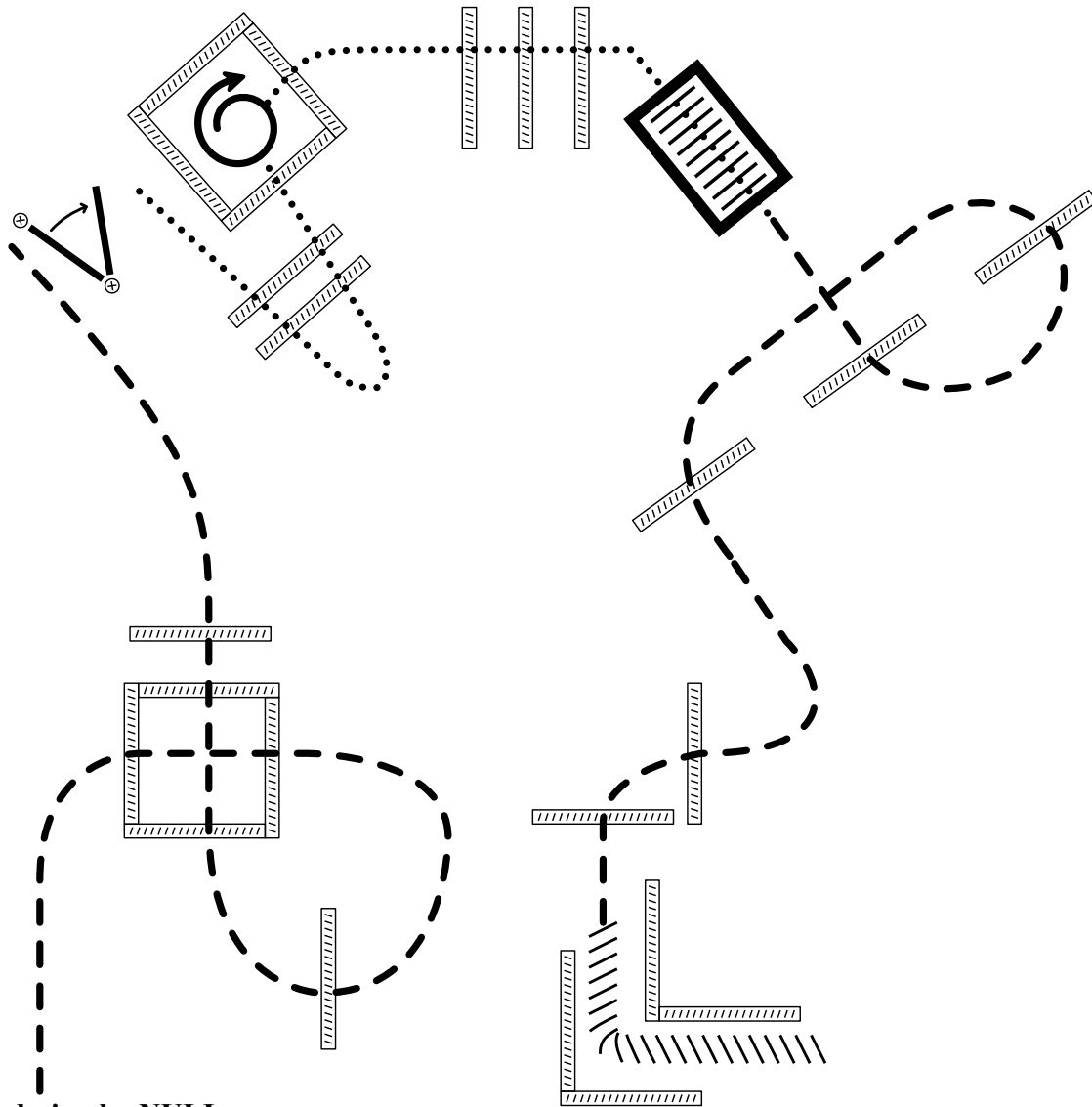

Pattern design by NULL

1. Jog through box and over poles to gate
2. Right hand push gate
3. Walk over poles and into box
4. 1 1/4 turn to the right in the box
5. Walk over poles and over bridge
6. Jog over poles
7. Jog over poles to L
8. Back the L to finish

Generated from Equiscribe for iOS  
Scan the code to see your results as they are posted



# Trail

## Age Divisions

Show: Summa In The Hamptons

Date: Aug 20, 2022

116. All Breed

120. Green Horse

121. Junior

123. Novice Youth

125. Novice Amateur

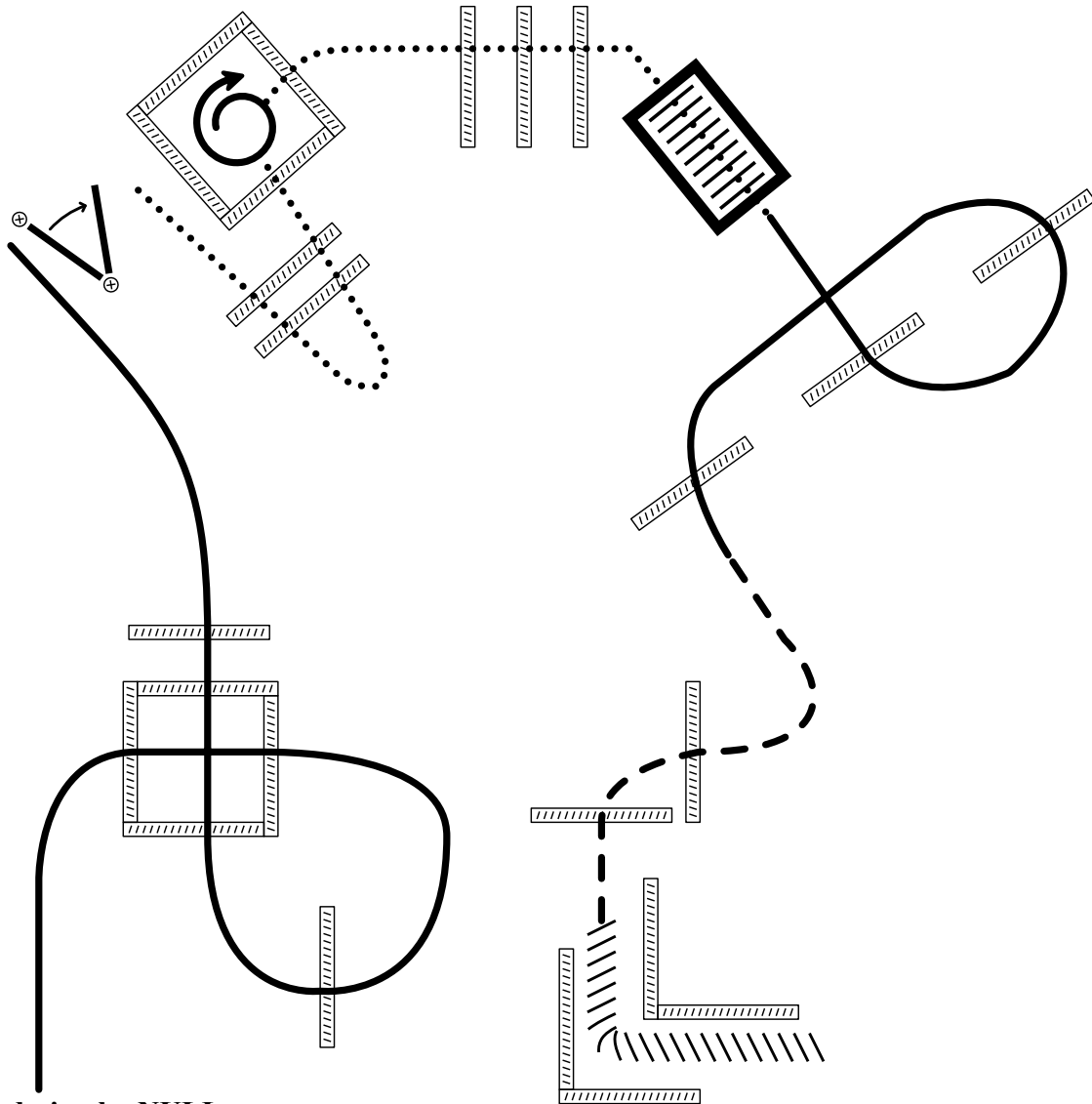

Pattern design by NULL

1. Lope on the right lead through box and over poles to gate
2. Right hand push gate
3. Walk over poles and into box
4. 1 1/4 turn to the right in the box
5. Walk over poles and over bridge
6. Lope on the left lead over poles
7. Jog over poles to L
8. Back the L to finish

Generated from Equiscribe for iOS  
Scan the code to see your results as they are posted





# Trail

## Age Divisions

122. Senior  
124. Youth 18 & Under  
126. Amateur SPB  
127. Amateur  
128. SPB

Show: Summa In The Hamptons

Date: Aug 20, 2022

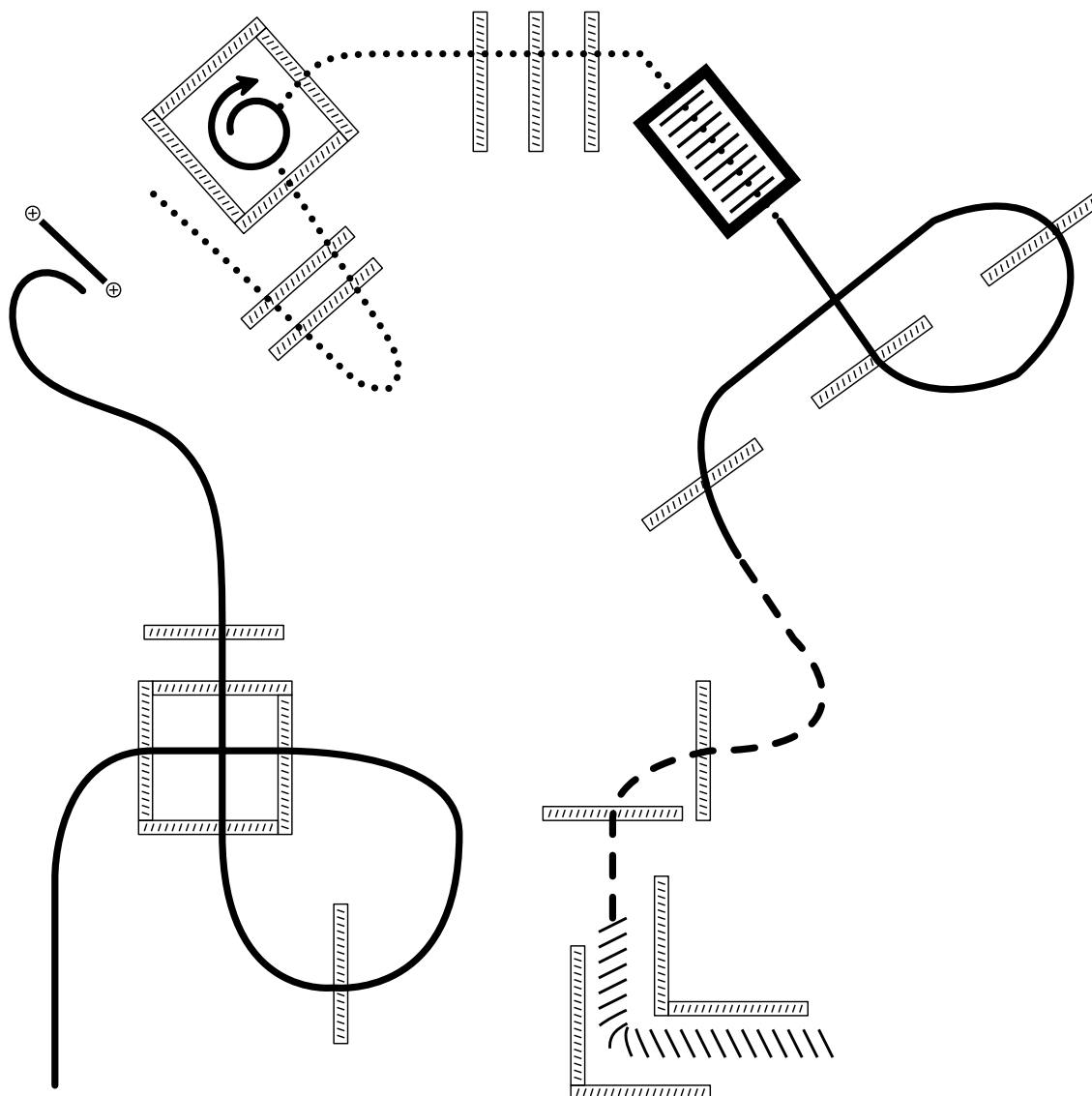

Pattern design by NULL

1. Lope on the right lead through box and over poles to gate
2. Left hand push gate
3. Walk over poles and into box
4. 1 1/4 turn to the right in the box
5. Walk over poles and over bridge
6. Lope on the left lead over poles
7. Jog over poles to L
8. Back the L to finish

Generated from Equiscribe for iOS  
Scan the code to see your results as they are posted



# Horsemanship

## Age Divisions

Show: Summa In The Hamptons

Date: Aug 20, 2022

161. Youth W/T 5-10

162. Youth W/T 11-18

163. Amateur W/T

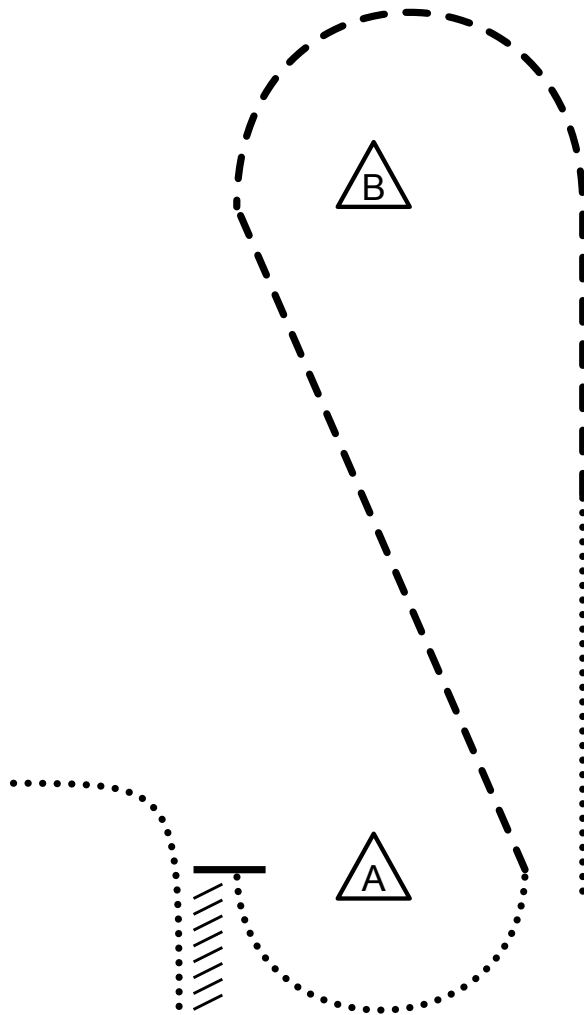

Pattern design by NULL

Be ready at A

1. Walk halfway to B
2. Jog halfway to B
3. Continue to jog diagonally back to A
4. Walk around A
5. Stop and back approximately two horse lengths
6. Walk straight away

Follow the instructions of your ring steward

Generated from Equiscribe for iOS  
Scan the code to see your results as they are posted



# Horsemanship

## Age Divisions

169. Novice Amateur  
166. Novice Youth  
167. Youth 13 & Under

Show: Summa In The Hamptons

Date: Aug 20, 2022

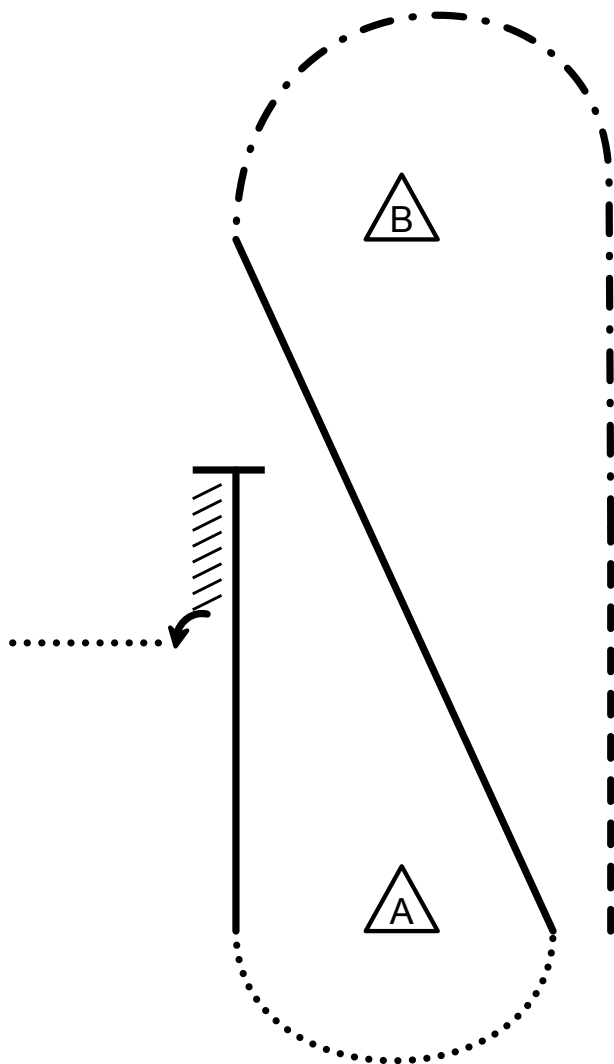

Be ready at A

1. Jog halfway to B
2. Extend the jog to and around B
3. Lope on the left lead diagonally back to A
4. Walk around A
5. Lope on the right lead halfway to B
6. Stop and back approximately two horse lengths
7. Perform a  $1\frac{1}{4}^\circ$  turn to the left
8. Walk straight away

Follow the instructions of your ring steward

Generated from Equiscribe for iOS  
Scan the code to see your results as they are posted



# Horsemanship

## Age Divisions

168. Youth 18 & Under

170. Amateur SPB

171. Amateur

Show: Summa In The Hamptons

Date: Aug 20, 2022

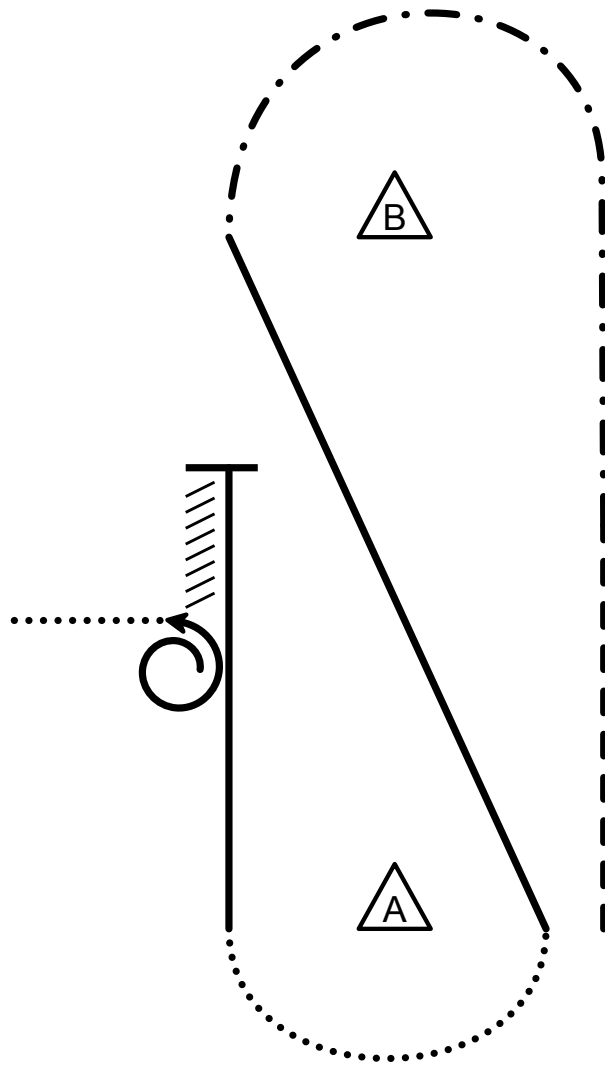

Be ready at A

1. Jog halfway to B
2. Extend the jog to and around B
3. Lope on the left lead diagonally back to A
4. Walk around A
5. Lope on the right lead halfway to B
6. Stop and back approximately two horse lengths
7. Perform a 1 1/4 turn to the left
8. Walk straight away

Follow the instructions of your ring steward

Generated from Equiscribe for iOS  
Scan the code to see your results as they are posted



# Western Riding

Age Divisions

172. Green

174. Novice Amateur

Show: Summa In The Hamptons

Date: Aug 20, 2022

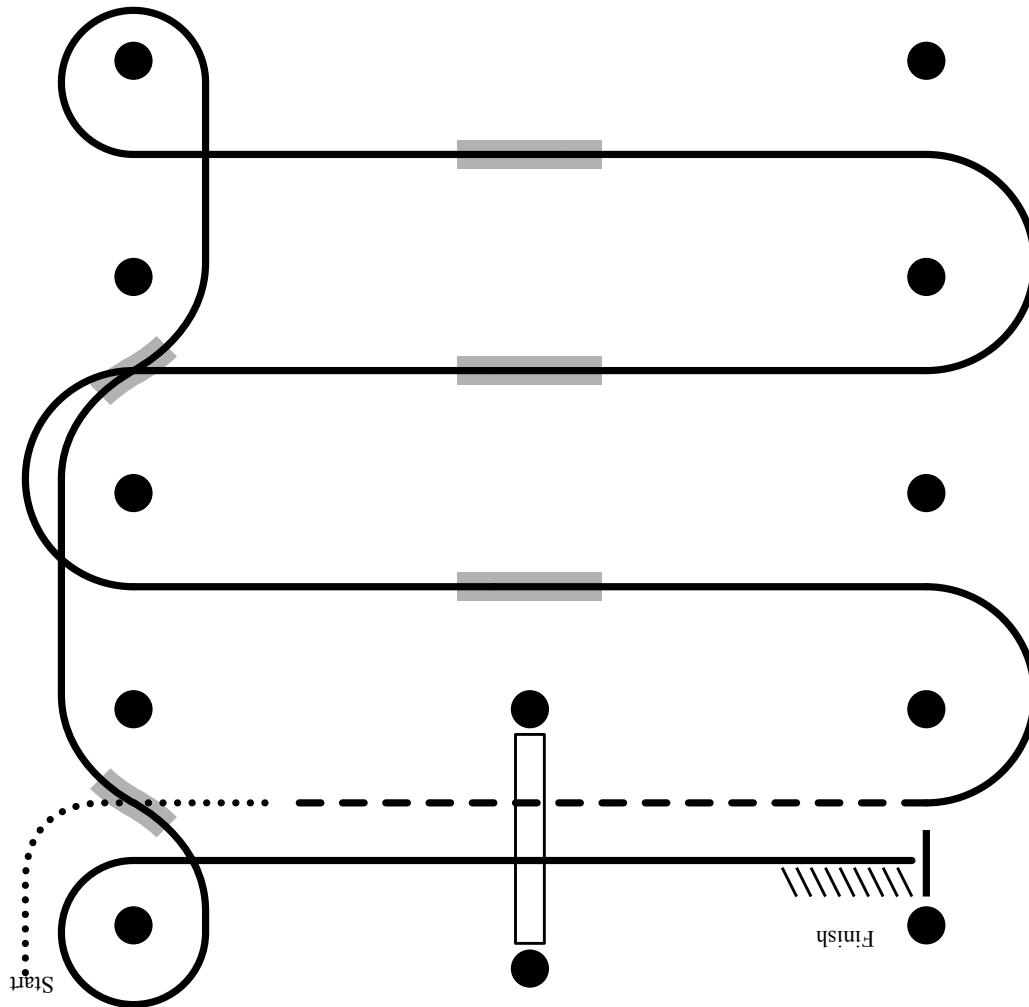

1. Walk, transition to jog, jog over log
2. Transition to left lead lope
3. First crossing change
4. Second crossing change
5. Third crossing change
6. circle and first line change
7. Second line change and circle
8. Lope log
9. Stop and back

Generated from Equiscribe for iOS  
Scan the code to see your results as they are posted



# Western Riding

Age Divisions

Show: Summa In The Hamptons

Date: Aug 20, 2022

173. Youth

175. Amateur

176. Open

177. SPB

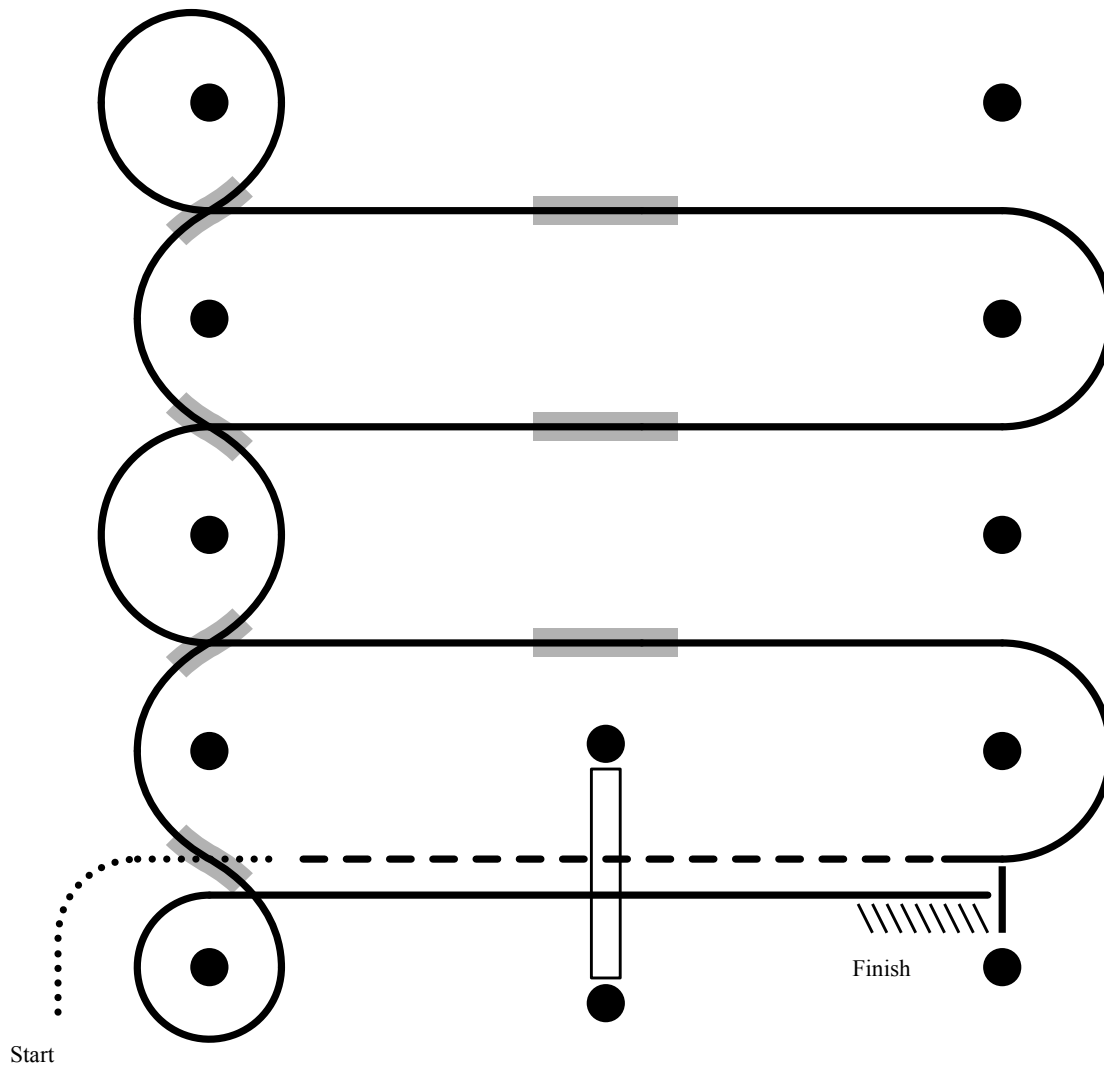

1. Walk, transition to jog, jog over log
2. Transition to the lope, on the left lead
3. First crossing change
4. Second crossing change
5. Third crossing change
6. Circle & first line change
7. Second line change
8. Third line change
9. Fourth line change & circle
10. Lope over log
11. Lope, stop & back

Generated from Equiscribe for iOS  
Scan the code to see your results as they are posted

